

2006 3/2-way stainless steel



Pneumatically operated 3 way seat valve CLASSIC

- For mixing or distributing mediums
- Controlled by a pilot valve or centrally by a valve island
- Flow optimized body in stainless steel or brass/ stainless steel
- Long service life and maintenance-free operation

Type 2002 can be combined with...



Type 6012/6014 P
Pilot valve

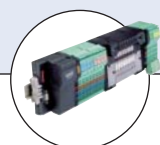

Type 8640/8644
Valve block

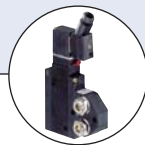

Type 5470
Solenoid valve

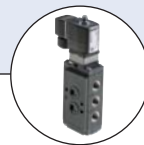

Type 6519 NAMUR



Type 8697
Feedback unit



The Bürkert 3 way seat valve, Type 2006, consists of a pneumatically operated CLASSIC actuator and a 3 way valve body. The actuator is available in two different materials, PA or PPS, depending on the ambient temperature. Available materials for the valve body include stainless steel and a brass/stainless steel variant. Interchanging of pressure and service ports enables different fluidic circuit functions, such as the mixing or distributing of mediums. The flow-optimized valve body of Type 2006 allows excellent flow rates. The tried and tested self-adjusting gland secures a high level of tightness and thus ensures reliable operation over years. The 3 way valve Type 2006 is controlled by a pilot valve, or by centralized automation using a valve island. It can be equipped easily with an electrical position indicator. For the user, the compact Type 2006 is thus often an economic alternative instead of two single shut-off valves.

Technical data	
Orifice	DN 15 - 50
Body materials	Stainless steel 316L
Nominal pressure	PN16 (body)
Actuator material	PA (PPS on request)
Seal material	PTFE
Media	Water, alcohol, oils, fuels, hydraulic fluid, alkaline solutions, salt solution, organic solutions, hot water, steam
Viscosity	Max. 600 mm ² /s
Packing gland (with silicone grease)	PTFE V-rings with spring compensation
Media temperature	-10 to +180°C
Ambient temperature	
PA actuator	-10 to +60°C
PPS actuator	
Actuator sizes Ø 50-80	+5 to +140°C
Actuator sizes Ø 125	+5 to +90°C, (up to 140°C for a short period)
Installation	As required, preferably with actuator in upright position
Control medium	Neutral gases, air
Max. pilot pressure	10 bar 7 bar with actuator Ø 125
Port connections	G thread acc. to EN ISO 228-1 NPT thread acc. to ANSI B 1.20.1 (RC thread on request)
Approval and Conformity	EGV 1935/2004 (optional) FDA (optional)

Materials

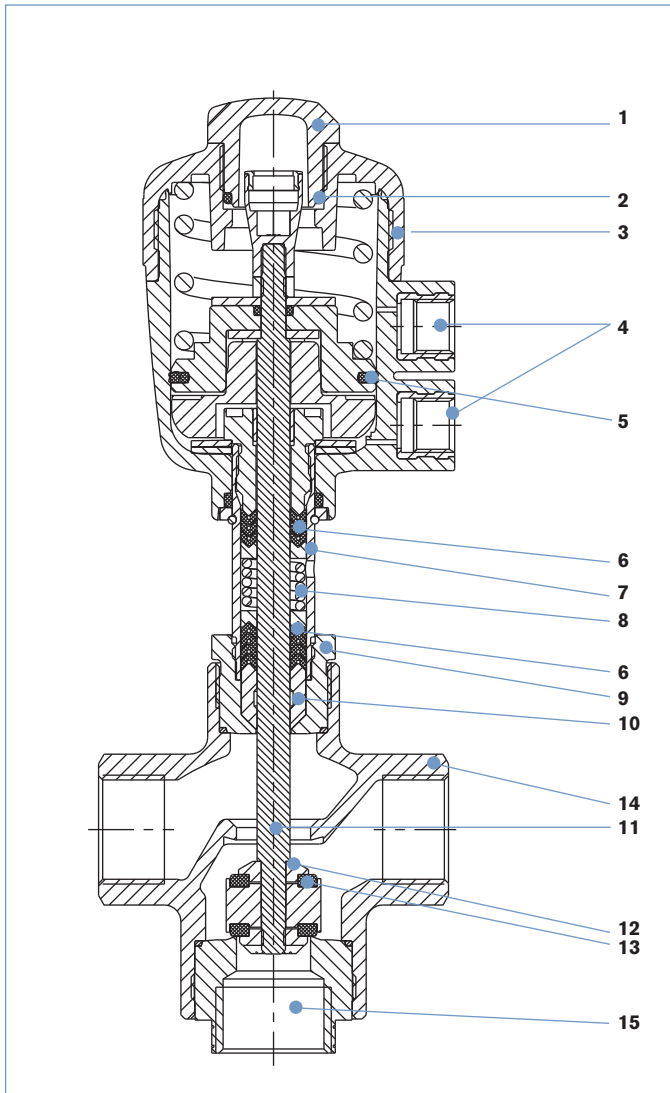

Description	Material
1 Transparent cap	Polycarbonate (PC) (with PPS - actuator PSU)
2 O-Ring	FKM
3 Actuator	Polyamide (PPS)
4 Pilot air ports G 1/4	Stainless steel 1.4305
5 Cylinder seal	NBR (with PPS - actuator FKM)
6 Spindle seal	PTFE
7 Tube ²⁾	Stainless steel 1.4401 / 316 Stainless steel 1.4404 / 316L ³⁾
8 Tension spring	Stainless steel 1.4310
9 Nipple ²⁾	Stainless steel 1.4401 / 316 Stainless steel 1.4404 / 316L ³⁾
10 Wiper	PTFE PEEK ¹⁾
11 Spindle	Stainless steel 1.4404 / 316L
12 Plug	Stainless steel 1.4404 / 316L
13 Seals	PTFE
14 Valve body	Stainless steel 1.4404 / 316L
15 Seat nipple	Stainless steel 1.4404 / 316L

¹⁾ For actuator size 125 mm

²⁾ One-piece with the drive sizes 63 mm to 125 mm

³⁾ For actuator sizes 63 mm to 125 mm

Temperature chart

■ **Note:** For PA actuators in the sizes 50 and 63, the combination of max. media temperature and max. ambient temperature is as shown in the following chart:

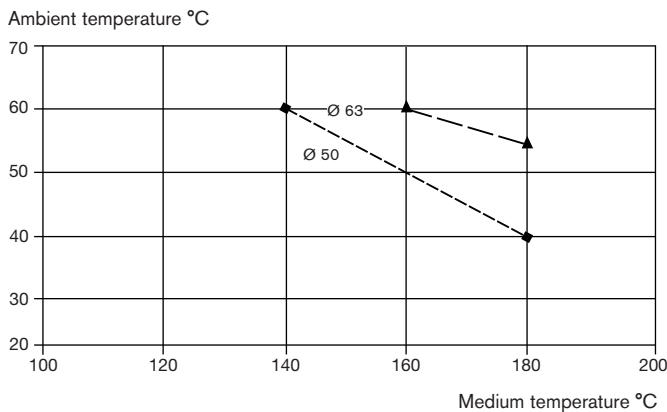

Connections for fluidic circuit functions C, D, E and F

Actuator with control function A

When de-energised port connection 1 is closed with spring

Fluidic circuit function	Connection - port		
	1	2	3
C	P	A	R
D	R	A	P
E	P1	A	P2
F	A	P	B

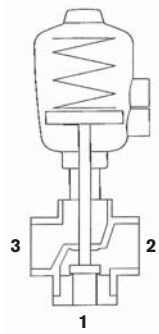

A, B service ports
P, P1, P2 pressure ports
R exhaust port

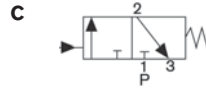

When de-energised, pressure port 1 closed, service port 2 exhausted

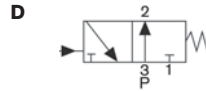

When de-energised, pressure port 3 connected to service port 2, exhaust port 1 closed

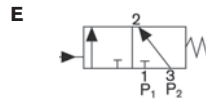

Mixer valve
When de-energised, pressure port 3 connected to service port 2, pressure port 1 closed

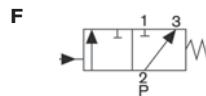

Distributor valve
When de-energised, pressure port 2 connected to service port 3, service port 1 closed

Dimensions [mm]

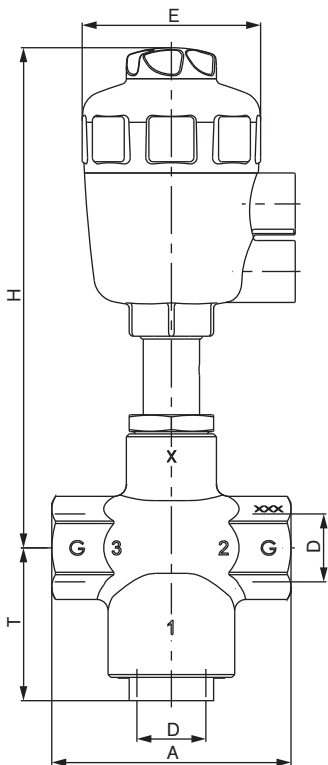

Orifice	Actuator size Ø	Port connection D	A	E	H	T	
15	50	G 1/2	85	64	178	54	
	63			80			220
20	50	G 3/4	85	64	178	54	
	63			80			220
25	63	G 1	105	80	220	54	
32	80	G 1 1/4	130	101	249	68	
	125			158			345
40	63	G 1 1/2	130	80	226	68	
	80			101			249
	125			158			345
50	125	G 2	150	158	352	72	

Ordering chart for valves with port 1 closed by spring action (other versions on request)

Threaded connection acc. to EN ISO 228-1

Control function	Port connection	Orifice [mm]	Actuator size Ø [mm]	Kv value water [m³/h]		Min. pilot pressure [bar]	Max. operating pressure to 180°C [bar]		Weight [kg]	Item no. PA actuator	Item no. PPS actuator
				1 → 2	2 → 3		1 → 2	2 → 3 2 → 1			
A 3/2 way, normally closed (NC) (port 1)	G 1/2	15	50	7	4.5	4.4	11	16	1.3	287 191	287 202
			63	8	4.5	4.7	16	16	1.6	287 192	287 203
	G 3/4	20	50	9	6.2	4.4	11	16	1.3	287 193	287 204
			63	11	5.6	4.7	16	16	1.6	287 194	287 205
	G 1	25	63	17	11	4.9	10	16	2.1	287 195	287 206
			80	32	21	6.0	9	16	4.3	287 196	287 207
	G 1 1/4	32	125	35	24	3.4	14	16	8.1	287 197	287 208
			80	35	24	6.0	9	16	4.3	287 199	287 210
	G 1 1/2	40	125	35	24	3.4	14	16	8.1	287 200	287 211
			50	51	35	4.3	10	16	9.5	287 201	287 212

Threaded connection with NPT thread acc. to ANSI B 1.20.1

Control function	Port connection	Orifice [mm]	Actuator size Ø [mm]	Kv value water [m³/h]		Min. pilot pressure [bar]	Max. operating pressure to 180°C [bar]		Weight [kg]	Item no. PA actuator	Item no. PPS actuator
				1 → 2	2 → 3		1 → 2	2 → 3 2 → 1			
A 3/2 way, normally closed (NC) (port 1)	NPT 1/2	15	50	7	4.5	4.4	11	16	1.3	292 542	292 553
			63	8	4.5	4.7	16	16	1.6	292 543	292 554
	NPT 3/4	20	50	9	6.2	4.4	11	16	1.3	292 544	292 555
			63	11	5.6	4.7	16	16	1.6	292 545	292 556
	NPT 1	25	63	17	11	4.9	10	16	2.1	292 546	292 557
			80	32	21	6.0	9	16	4.3	292 547	292 558
	NPT 1 1/4	32	125	35	24	3.4	14	16	8.1	292 548	292 559
			80	35	24	6.0	9	16	4.3	292 550	292 560
	NPT 1 1/2	40	125	35	24	3.4	14	16	8.1	292 551	292 561
			50	51	35	4.3	10	16	9.5	292 552	292 562

i Further versions on request

 Port connection
RC thread

Pilot pressure chart (CFA, flow direction 3 g 2)

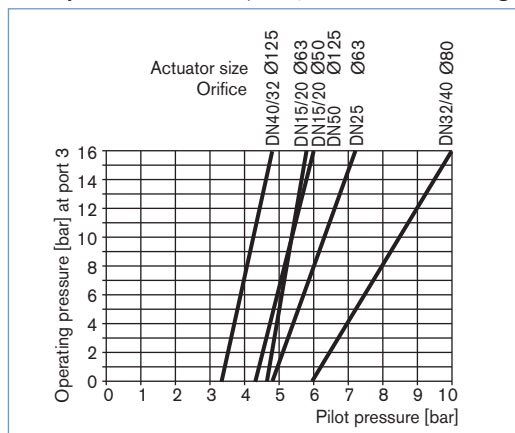

Ordering chart for accessories

3/2 way pilot valves with banjo bolts

Seal material valve FKM, seal material banjo bolt NBR

Valve for actuator size [Ø mm]	Type	Pressure inlet P (valve body)	Service port A (banjo bolt)	Orifice [mm]	Q _{Nn} value air [l/min]	Pressure range [bar]	Electrical coil connection Ind. Std.	Power consumption [W]	Item no. Voltage/frequency [V/Hz]	
									024/DC	230/50
50-63	6012P	Tube fitting ø6 mm	G 1/4	1.2	48	0-10	Form B	4	552 283	552 286
50-125	6014P	G 1/4	G 1/4	2	120	0-10	Form A	8	424 103	424 107

Cable plug Type 2507, Form B or Type 2508, Form A

	Item no.
Type 2507, Form B Industrial standard, 0 to 250 V without circuitry (Type 6012 P)	423 845
Type 2508, Form A acc. DIN EN 175301-803, 0 to 250 V without circuitry (Type 6014 P, Type 0331P)	008 376

For further accessories see the accessories datasheet Type 2XXX for the full options programme.

Type 8697 Pneumatic feedback unit

End position feedback											
Inductive Switch 3-wire PNP	Inductive Switch 2-wire NAMUR	Inductive Switch 2-wire 24V DC	Micro Switch 24V DC	Micro Switch 50-250V AC/DC	Feedback status LEDs	Electrical connection	ATEX / IECEX Cat. 3D/G Zone 22/2 ²⁾	ATEX / IECEX Cat. 2D/G Zone 21/1 ³⁾	ATEX / IECEX Cat. 2G Zone 1 ⁴⁾	cULus	Item no. Actuator series CLASSIC Types 20XX
Feedback (without pilot valve)											
2					yes	Cable gland				yes	248 827
2					yes	Cable gland	yes				255 851
2					yes	M12 connector	yes				255 858
2					yes	M12 connector				yes	250 472
	2				yes	Cable gland		yes			248 831
	2				yes	Cable gland			yes		255 863
		2			yes	Cable gland				yes	248 826
		2			yes	Cable gland	yes				255 850
			2			Cable gland				yes	248 833
				2		Cable gland				yes	248 825

Note: cULus only valid for versions without ATEX approval

²⁾ II 3D Ex tc IIIC T135 / II 3G Ex nA IIC T4 Gc

³⁾ II 2D Ex ia IIIC T135°C IP64 / II 2G Ex ia IIC T4 Gb

⁴⁾ II 2G Ex ia IIC T4 Gb

Adapter kit

Description	Actuator size	Control function	Item no.
Feedback	Ø50/63/80 mm	universal	682 264
Feedback	Ø125 mm	universal	682 265

Weitere Informationen siehe Datenblatt Typ 8697

To find your nearest Bürkert facility, click on the orange box →

www.burkert.com

In case of special application conditions, please consult for advice.

We reserve the right to make technical changes without notice.

1606/2_EU-en_00895288