

## Electromagnetic Flowmeter



- Sensor without moving parts
- Working as a flowmeter and/or as an On/Off controller
- Application adjusted calibration by Teach-In
- Clean in place (CIP)
- FDA approved material

Type 8041 can be combined with...



**Type S020**  
INSERTION  
T-fitting

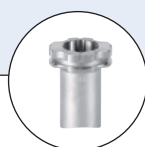

**Type S020**  
Spigot



**Type 8025**  
Universal transmitter/  
batch controller (remote version)



**Type 8802-GD**  
TopControl System

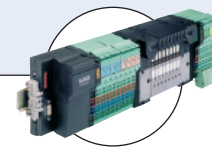

**Type 8644**  
Valve islands with  
electronic I/O

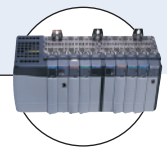

**PLC**

The electromagnetic flowmeter 8041 has been designed to measure flow rate of neutral and slightly aggressive fluids with a conductivity of more than 20  $\mu\text{S}/\text{cm}$  in DN06 to DN400 pipes.

It is fitted with a 4... 20 mA output, a pulse output and a relay output. The different parameters can be programmed by means of 5 switches, a push-button and a 10 LED bargraph.

The flowmeter is a magmeter made up of an electronic module and a sensor which armature material is PVDF or stainless steel. It is available:

- with G2" connection for the version with a PVDF sensor
- with G2" or clamp connection for the version with a stainless steel sensor.

The version with a stainless steel sensor can be used in applications with higher pressures (PN16) and higher temperatures (150°C).

Technical data	
<b>General data</b>	
<b>Compatibility</b>	with fittings S020 (see corresp. datasheet)
<b>Materials</b>	
Housing, cover, nut	PC (glass fibre reinforced for housing)
PVDF sensor version	PPA (glass fibre reinforced)
Stainless steel sensor version	Stainless steel / NBR / PA with neoprene seal
Screws / Seal / Cable glands	
Wetted parts materials	
Sensor holder	PVDF or Stainless steel 1.4404/316L
Electrodes	Stainless steel 1.4404/316L
Seals	G2" connection: FKM (FDA approved), [EPDM (KTW approved)] Clamp connection: EPDM or FEP (to be ordered separately)
Earth ring (PVDF sensor version)	Stainless steel 1.4404/316L
Electrode holder (St. Steel sensor version)	PEEK (FDA approved)
<b>Surface finishing quality</b>	Ra < 0.8 $\mu\text{m}$ (Clamp connection)
<b>Electrical connections</b>	2 cable glands M20 x 1.5
<b>Recommended cable</b>	0.5 to 1.5 mm <sup>2</sup> cross-section, shielded cable, 6... 12 mm diameter (if only one cable is used per cable gland) OR 4 mm diameter (if two cables are used per cable gland with using the supplied multi-way seal)
<b>Environment</b>	
<b>Ambient temperature</b>	-10 to +60°C (14 to 140°F) (operating) -20 to +60°C (-4 to 140°F) (storage)
<b>Relative humidity</b>	< 80%, without condensation
<b>Height above sea level</b>	Max. 2000 m

Complete device data (Fitting S020 + flowmeter)	
<b>Pipe diameter</b>	
G2" connection	DN06 to DN400
Clamp connection	DN32 to DN100
<b>Measuring range</b>	0.2 to 10 m/s
<b>Sensor element</b>	Electrodes
<b>Fluid temperature</b>	see Pressure/Temperature diagram
PVDF sensor version	0 to 80°C (32 to 176°F) (depends on fitting)
Stainless steel sensor version	-15 to 150°C (5 to 302°F) (depends on fitting)
<b>Fluid pressure max.</b>	see pressure/temperature diagram
PVDF sensor version	PN10 (145.1 PSI)
Stainless steel sensor version	PN10 (145.1 PSI) (with plastic fitting) - PN16 (232.16 PSI) (with metal fitting)
<b>Conductivity</b>	min. 20 µS/cm
<b>Accuracy</b>	
Teach-In	±0.5% of Reading <sup>1)</sup> (at the teach flow rate value)
Standard K-factor	±3.5% of Reading <sup>1)</sup>
<b>Linearity</b>	±0.5% of F.S. <sup>1)</sup>
<b>Repeatability</b>	±0.25% of Reading <sup>1)</sup>

<sup>1)</sup> Under reference conditions i.e. measuring fluid=water, ambient and water temperature = 20°C (68°F), applying the minimum inlet and outlet pipe straights, matched inside pipe dimensions.

\* F.S.= Full scale (10 m/s)

Electrical data	
<b>Power supply</b>	18 - 36 V DC filtered and regulated (3 wires)
<b>Reversed polarity of DC</b>	protected
<b>Current consumption</b>	≤ 220 mA (at 18 V DC)
<b>Output</b>	
Signal current	4... 20 mA (sink or source by wiring), 100 ms refresh time; max. loop impedance: 1100 Ω at 36 V DC; 330 Ω at 18 V DC
Frequency	0... 240 Hz, duty cycle = 50%±1%; 100 mA max., protected against short-circuits and polarity reversals.
Relay	Normally open or normally closed (depending on wiring), 3 A, 250 V AC
<b>4... 20 mA output accuracy</b>	±1%
<b>Alarm</b>	
Full scale exceeding	22 mA and 256 Hz
Fault signalling	22 mA and 0 Hz
<b>User parameter</b>	Saved in EEPROM

Standards, directives and approvals	
<b>Protection class</b>	IP65
<b>Standards and directives</b>	
EMC	EN 50081-1, EN 61000-6-2
Low voltage (LVD)	EN 61010-1
Pressure	Complying with article 3 of §3 from 97/23/CE directive.*
Vibration	EN 60068-2-6
Shock	EN 60068-2-27
<b>Approval</b>	FDA

\* For the 97/23/CE pressure directive, the device can only be used under following conditions (dependent on max. pressure, pipe diameter and fluid).

Type of fluid	Conditions
Fluid group 1, §1.3.a	Forbidden
Fluid group 2, §1.3.a	DN ≤ 32, or DN > 32 and PN*DN ≤ 1000
Fluid group 1, §1.3.b	PN*DN ≤ 2000
Fluid group 2, §1.3.b	DN ≤ 200 or PpN ≤ 10 or PN*DN ≤ 5000

## Pressure/Temperature diagram

Please be aware of the fluid pressure/temperature dependence according to the respective fitting+flowmeter material as shown in the diagrams.

### 8041 with a PVDF sensor

(depending on the fitting material)

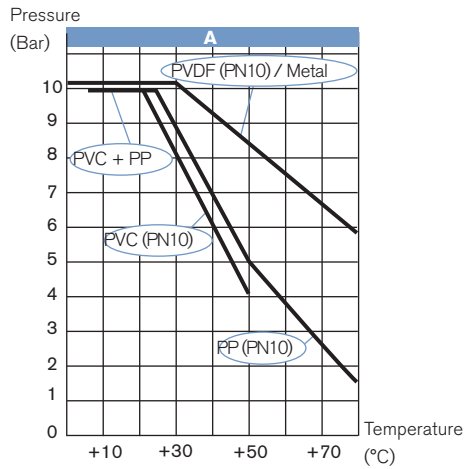

A: Application range for complete device (fitting + flowmeter)

### 8041 with a stainless steel sensor

(depending on the fitting material)

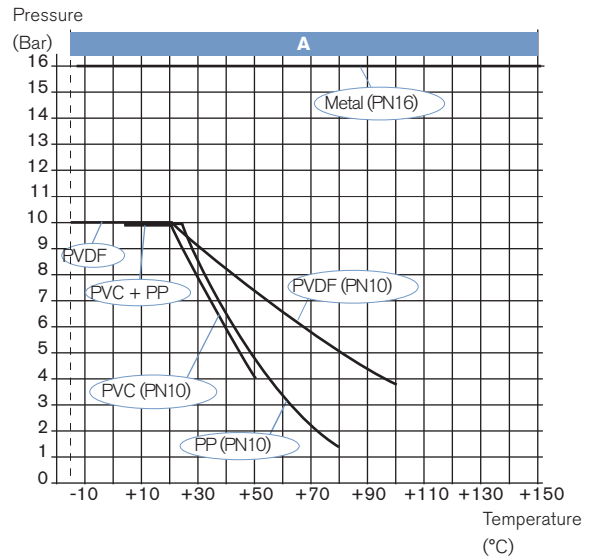

## Main features and programming

### Using as a flowmeter

- Programming of the full scale
  - selection of a predefined measuring range: 0 to 2, to 5 or to 10 m/s
  - selection by Teach-In: with the actual max. flow velocity of the application
- 4... 20 mA current output
- 0... 240 Hz frequency output
- Relay output: switching mode either window or hysteresis, on low or high switching threshold
- Relay Time delay before switching
- Filter
- Alarm:
  - for full scale exceeding with 22 mA and 256 Hz
  - for fault signalling with 22 mA and 0 Hz

### Using as an ON/OFF control

- Flow detection with switching thresholds, defined as a percentage of max. flow rate.
- Adjustment of the full scale of the device accordingly to the customer process full scale.

## Possible applications

Flow control of conductive fluids, contaminated or not:

- ▶ Waste water treatment
- ▶ Flow control of drinking water (FDA approval)
- ▶ Laundries: measurement and control of the water consumption
- ▶ Swimming pools: pump protection and flow control
- ▶ Food-processing industry: monitoring of the cleaning cycles (FDA approval)
- ▶ Irrigation

## Design

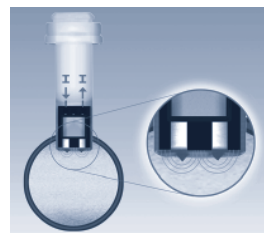

The E-shaped magnetic system inside the sensor induces a magnetic field into the fluid, which is perpendicular to the direction of flow. Two electrodes are in galvanic contact with the liquid.

Based on the Faraday law a voltage can be measured between these electrodes once a liquid (min. conductivity of 20  $\mu\text{S}/\text{cm}$ ) flows along the pipe. This voltage is proportional to the flow velocity. Using the K-factor for the individual pipe diameter the speed of flow is converted into volume per time.

Display on PCB

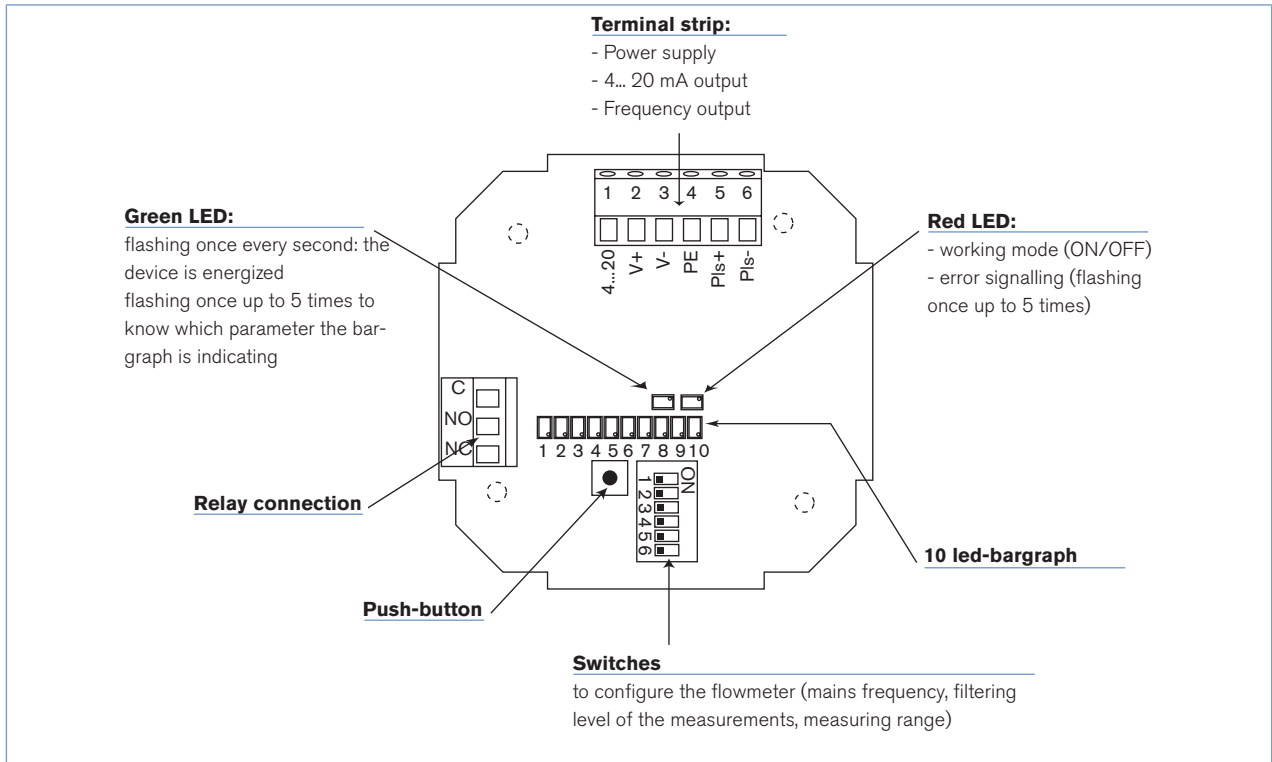

Installation

The 8041 flowmeter can easily be installed into any Bürkert INSERTION fitting system (S020) by just fixing the main nut.

Minimum straight upstream and downstream distances must be observed. According to the pipe's design, necessary distances can be bigger or use a flow conditioner to obtain the best accuracy. For more information, please refer to EN ISO 5167-1.

EN ISO 5167-1 prescribes the straight inlet and outlet distances that must be complied with when installing fittings in pipe lines in order to achieve calm flow conditions. The most important layouts that could lead to turbulence in the flow are shown below, together with the associated prescribed minimum inlet and outlet distances. These ensure calm, problem-free measurement conditions at the measurement point.

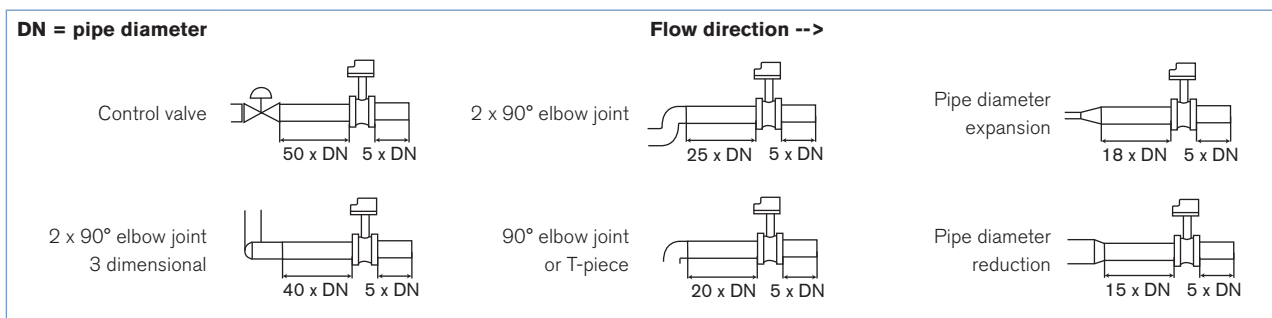

It is advisable to mount the flowmeter at a 45° angle to the horizontal centre of the pipe to avoid having deposits on the electrodes and false measurements due to air bubbles

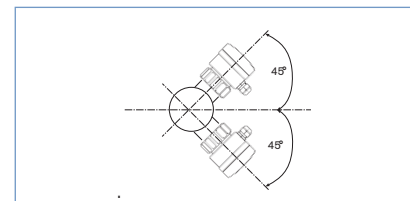

Installation (continued)

The device can be installed into either horizontal or vertical pipes. Mount the 8041 in the following correct ways to obtain an accurate flow measurement.

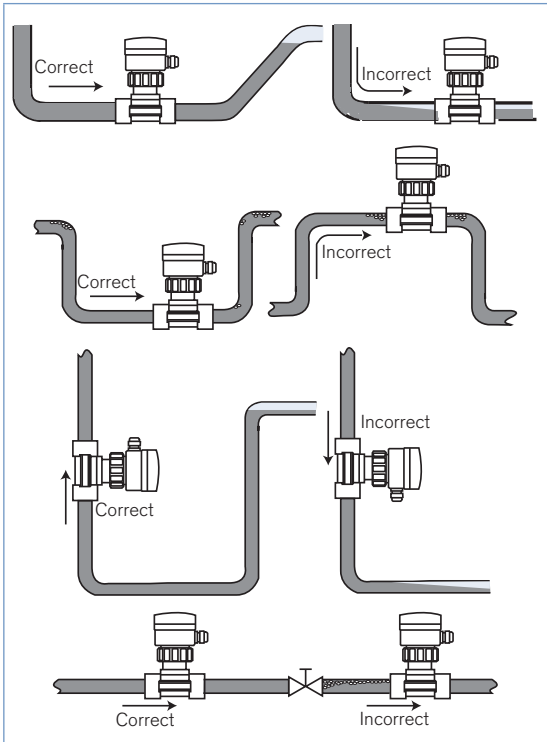

Pressure and temperature ratings must be in accordance to the selected fitting material. The suitable pipe size is selected using the diagram Flow/Velocity/DN.

The flowmeter is not designed for gas or steam flow measurement.

Diagram Flow/Velocity/DN

Example:

- Flow: 10 m<sup>3</sup>/h
- Ideal flow velocity: 2... 3 m/s

For these specifications, the diagram indicates a pipe size of DN40 [or DN50 for (\*) mentioned fittings]

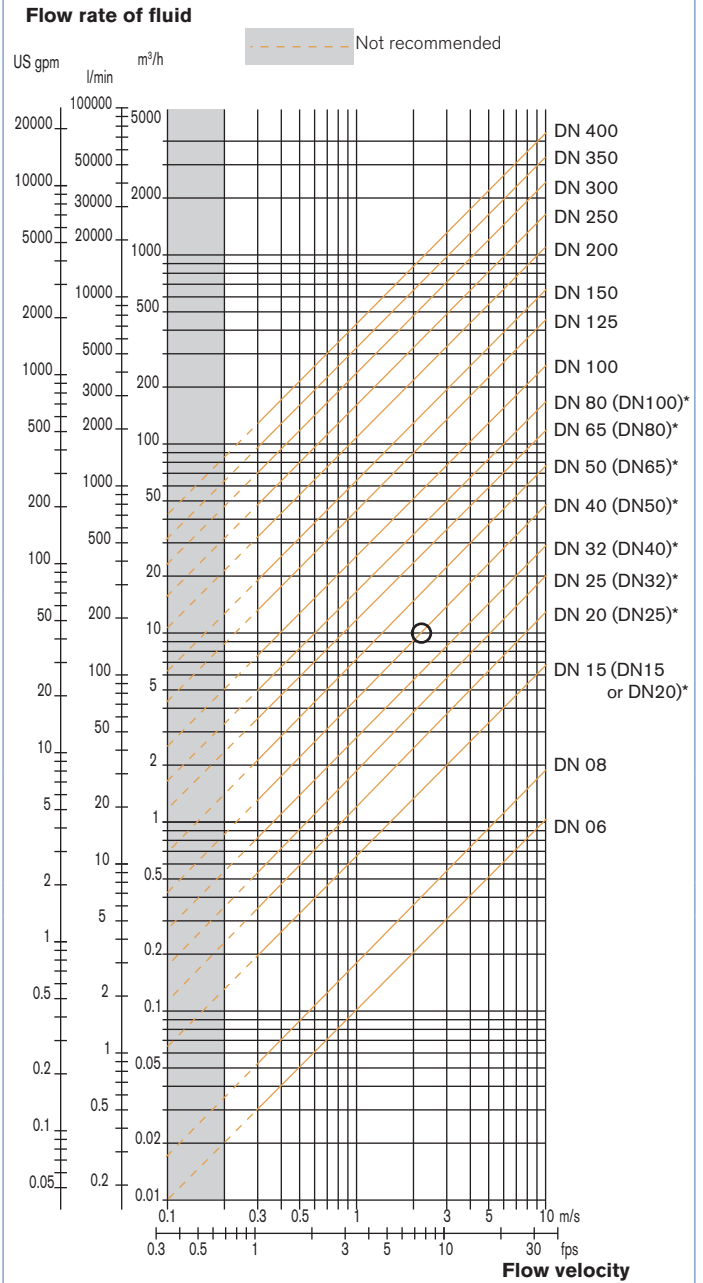

\* for following fittings with process connection:  
 external thread acc. to SMS 1145  
 weld end acc. to SMS 3008, BS 4825/ASME BPE or DIN 11850 Series 2  
 Clamp acc. to SMS 3017/ISO 2852, BS 4825/ASME BPE or DIN 32676

Dimensions [mm]

G2" connection version

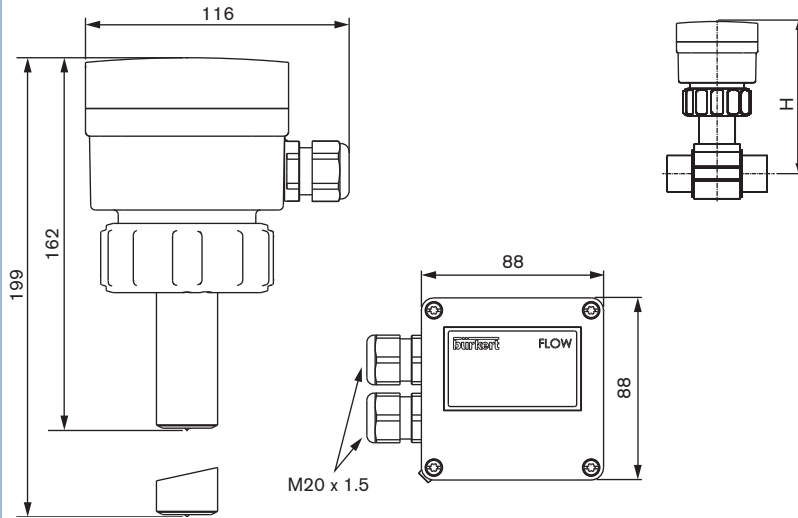

DN	H			
	T-Fitting	Saddle	Plastic spigot	Metal spigot
06	163			
08	163			
15	168			
20	166			
25	166			
32	169			
40	173			169
50	179	204		174
65	179	203	187	180
80		207	193	185
100		212	200	195
110		208		
125		215	235	206
150		225	242	217
180		249		
200		261	263	238
250			281	298
300			293	317
350			306	329
400			321	

**Note:** The length of the sensor finger depends on the fitting used. See data sheet Type S020 or available fitting DN diagram on page 9.

Clamp connection version

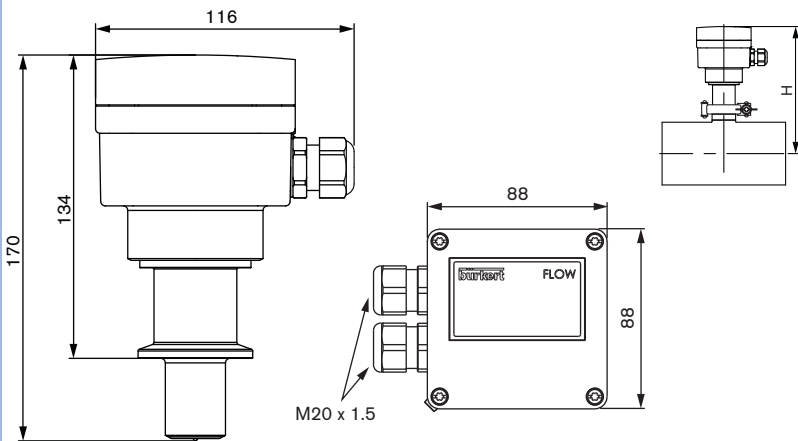

DN	H
32	181
40	186
50	191
65	199
80	205
100	211

## Ordering information and chart for flowmeter Type 8041

### • G2" connection to use with S020 Fitting for flowmeter with G2" connection.

A complete flowmeter Type 8041 with G2" connection consists of a flowmeter Type 8041 (with G2" connection) and a Bürkert fitting Type S020  
The following information is necessary for the selection of a complete device:

- **Item no.** of the desired flowmeter **Type 8041** (see ordering chart, below)
- **Item no.** of the selected fitting **Type S020** for flowmeter with G2" connection (see separate data sheet) [More info.](#)

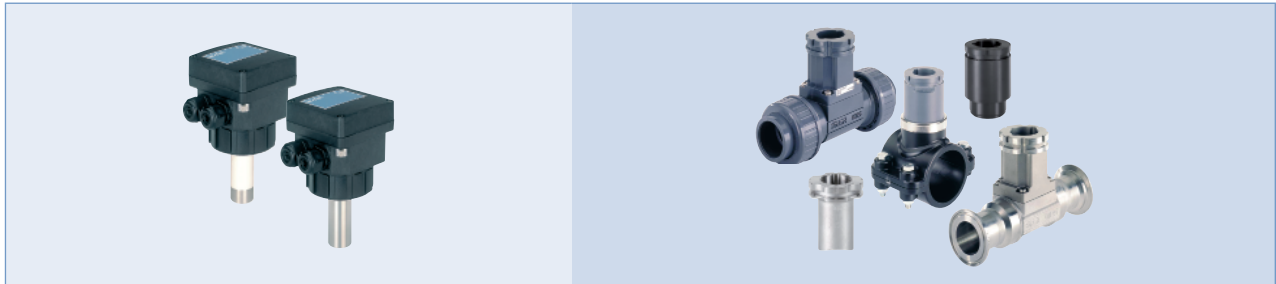

Voltage supply	Output	Relay	Housing material	Seals	Sensor version	Electrical connection	Item no.
18 - 36 V DC	4... 20 mA, frequency	1	PC	FKM	short, PVDF	2 cable glands	558 064
					long, PVDF	2 cable glands	558 065
			PPA	FKM	short, stainless steel (FDA)	2 cable glands	552 779
					long, stainless steel (FDA)	2 cable glands	552 780

**Note:** 1 EPDM seal contained in the kit 551775 , 1 relay connection kit 552 812 are supplied with each flowmeter.

### • Clamp connection to use with S020 Fitting for flowmeter with clamp connection.

A complete flowmeter Type 8041 with clamp connection consists of a flowmeter Type 8041 (with clamp connection), a Bürkert fitting Type S020, a clamp collar and a fitting/flowmeter seal

The following information is necessary for the selection of a complete device:

- **Item no.** of the desired flowmeter **Type 8041** (see ordering chart, below)
- **Item no.** of the selected fitting **Type S020** for flowmeter with clamp connection (see separate data sheet) [More info.](#)
- **Item no.** of the selected fitting/flowmeter seal - EPDM or FEP (see ordering chart, p. 8)
- **Item no.** of the clamp collar (see ordering chart, p. 8)

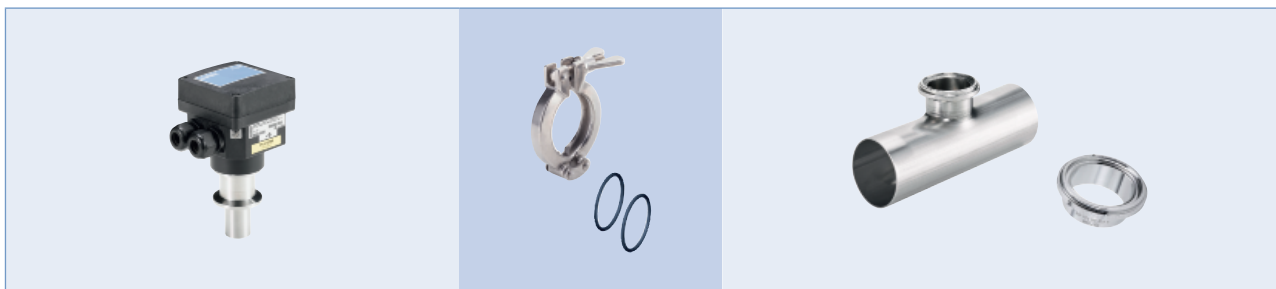

Voltage supply	Output	Relay	Housing material	Fitting/flowmeter seals*	Sensor version	Electrical connection	Item no.
18 - 36 V DC	4... 20 mA, frequency	1	PPA	EPDM or FEP	Clamp, stainless steel (FDA)	2 cable glands	564 688

**Note:** 1 Kit 565384 and 1 relay connection kit 552 812 are supplied with each flowmeter.

\* Has to be ordered separately

**Ordering chart - accessories for flowmeter Type 8041** (has to be ordered separately)

Specifications	Item no.
Set with 2 cable glands M20 x 1.5 + 2 neoprene flat seals for cable gland or plug + 2 screw-plugs M20 x 1.5 + 2 multiway seals 2 x 6 mm	449 755
Set with 2 reductions M20 x 1.5 /NPT1/2" + 2 neoprene flat seals for cable gland or plug + 2 screw-plugs M20 x 1.5	551 782
Relay connection kit with 1 screw terminal strip + 1 protection cap + 1 rilsan + 1 mounting instruction sheet	552 812
3 points calibration certificate (device combined with a S020 fitting, only for DN ≤ 200)	550 676
FDA - Approval (only stainless steel sensor version)	803 724
<b>For G2" connection version</b>	
Set with 1 stopper for unused cable gland M20 x 1.5 + 1 multiway seal 2 x 6 mm for cable gland + 1 green FKM seal for the sensor + 1 mounting instruction sheet	558 102
Snap ring	619 205
PC union nut	619 204
PPA union nut	440 229
Set with 1 green FKM and 1 black EPDM seal	552 111
<b>For clamp connection version</b>	
Set with 1 stopper for unused cable gland M20 x 1.5 + 1 multiway seal 2 x 6 mm for cable gland	565 384
1 EPDM fitting/flowmeter seal	730 837
1 FEP fitting/flowmeter seal	730 839
Clamp collar	731 164

**Ordering chart for remote electronics Type 8025 which can be connected to the 8041**

Version	Description	Voltage supply	Output	Relays	Sensor version	Electrical connection	Item no.
Panel	<b>8025 "Universal"</b> , 2 totalizers	18-30 V DC	4... 20 mA, pulse	None	8041	Terminal strip	419 538
				2	8041	Terminal strip	419 537
	<b>8025 "Batch"</b> , 2 totalizers, 1 flowrate	18-30 V DC	-	2	8041	Terminal strip	419 536
Wall	<b>8025 "Universal"</b> , 2 totalizers	18-30 V DC	4... 20 mA, pulse	None	8041	3 cable glands	419 541
				2	8041	3 cable glands	419 540
		115-230 V AC	4... 20 mA, pulse	None	8041	3 cable glands	419 544
	<b>8025 "Batch"</b> , 2 totalizers, 1 flowrate	18-30 V DC	-	2	8041	5 cable glands	433 740



**Interconnection possibilities with other Bürkert devices**

**Type 8802-DD -**  
Process control valve  
4... 20 mA current output

**Type 5281 -**  
Solenoid valve  
Relay output

**Type 8025 -**  
Universal transmitter/  
batch controller  
Wall-mounted or panel-mounted  
Frequency output

**Type 8041 -**  
Electromagnetic flowmeter  
with clamp connection

**Type 8041 -**  
Electromagnetic flowmeter  
with G2" connection

**Type S020 -**  
Insertion fitting for flowmeter  
with clamp connection  
(see corresp. data sheet)

**Type S020 -**  
Insertion fitting for flowmeter  
with G2" connection  
(see corresp. data sheet)

		DN06	DN08	DN32	DN50	DN65	DN100	DN200	DN350	DN400	
<b>Available S020 fittings for flowmeter with connection</b>	<b>G2"</b>	<b>T-fitting</b>	(1) Short sensor								
		<b>Welding socket</b>				Short sensor		Long sensor			
		<b>Fusion spigot</b>				Short sensor		Long sensor			
		<b>Screw-on</b>						Long sensor			
		<b>Saddle</b>				Long sensor					
		<b>Clamp</b>	<b>T-fitting</b>								
	<b>Welding socket</b>										

<sup>(1)</sup> DN06 and DN08 in stainless steel S020 only, 8041 with stainless steel sensor recommended

To find your nearest Bürkert office, click on the orange box →

[www.burkert.com](http://www.burkert.com)

In case of special application conditions,  
please consult for advice.

Subject to alteration.  
© Christian Bürkert GmbH & Co. KG

1501/12\_EU-en\_00891911